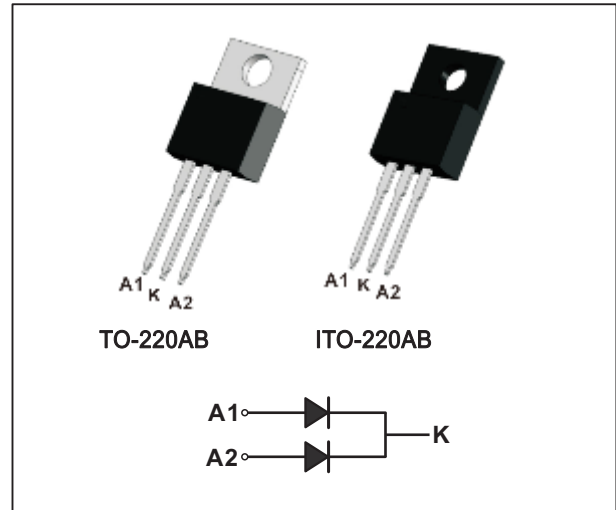

SCHOTTKY BARRIER RECTIFIERS
Reverse Voltage - 40 to 200 V
Forward Current - 20 A
FEATURES

- High current capability
- Low forward voltage drop
- Low power loss, high efficiency
- High surge capability
- High temperature soldering guaranteed
- Mounting position: any

Mechanical data

- Case: TO-220AB
- Approx. Weight: 1.9g (0.067oz)
- Case: ITO-220AB
- Approx. Weight: 2.1g (0.07oz)
- Terminals: Lead solderable per MIL-STD-202, Method 208

MAXIMUM RATINGS AND ELECTRICAL CHARACTERISTICS

Ratings at 25°C ambient temperature unless otherwise specified

CHARACTERISTICS	TO-220	MBR2040CT	MBR2045CT	MBR2060CT	MBR20100CT	MBR20150CT	MBR20200CT	Units	
	ITO-220	MBR2040FCT	MBR2045FCT	MBR2060FCT	MBR20100FCT	MBR20150FCT	MBR20200FCT		
Maximum Recurrent Peak Reverse Voltage	V_{RRM}	40	45	60	100	150	200	V	
Maximum RMS voltage	V_{RMS}	28	31.5	42	70	105	140	V	
Maximum DC Blocking Voltage	V_{DC}	40	45	60	100	150	200	V	
Maximum Average Forward Rectified Current per diode per device	$I_{F(AV)}$	10 20						A	
Peak Forward Surge Current, 8.3ms Single Half Sine-wave Superimposed on Rated Load (JEDEC method) per diode	I_{FSM}	150						A	
Max Instantaneous Forward Voltage at 10 A(per diode)	V_F	0.70		0.75	0.85	0.90	0.92	V	
Maximum DC Reverse Current at Rated DC Reverse Voltage $T_a = 25^\circ\text{C}$ $T_a = 125^\circ\text{C}$	I_R	0.1 20			0.05 20			mA	
Typical Junction Capacitance ⁽¹⁾	C_j	600		400				pF	
Typical Thermal Resistance ⁽²⁾	$R_{\theta JA}$	45						°C/W	
Operating Junction Temperature Range	T_j	-55 ~ +150				-55 ~ +175			°C
Storage Temperature Range	T_{stg}	-55 ~ +150				-55 ~ +175			°C

(1) Measured at 1 MHz and applied reverse voltage of 4 V D.C

(2) P.C.B. mounted with 10cmX10cmX1mm copper pad areas.

Fig.1 TYPICAL FORWARD CURRENT DERATING CURVE

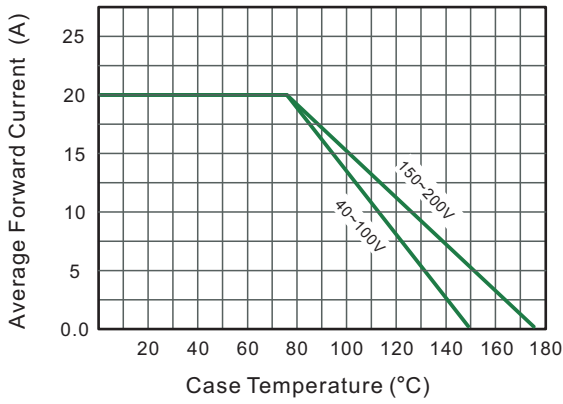

Fig.2 Typical Reverse Characteristics

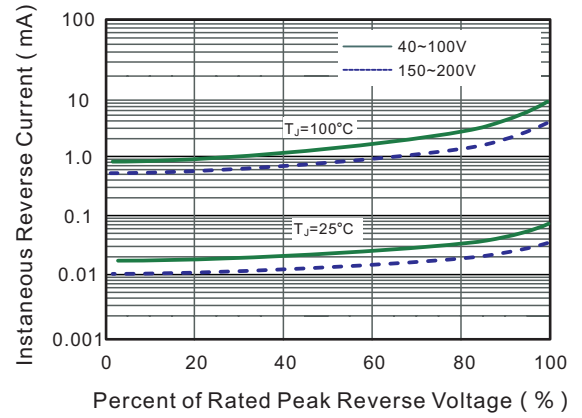

Fig.3 Typical Forward Characteristic(per leg)

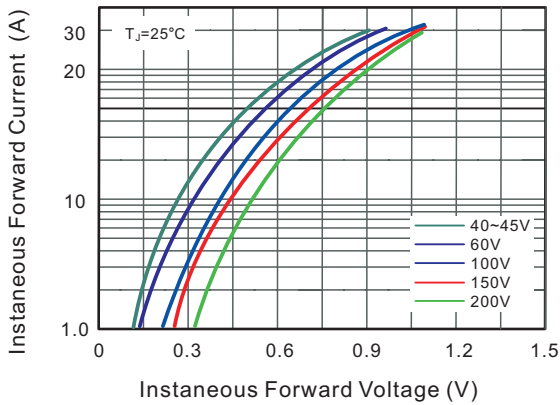

Fig.4 Typical Junction Capacitance

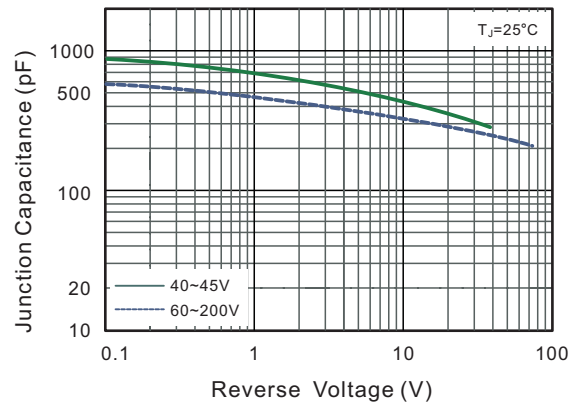

Fig.5 Maximum Non-Repetitive Peak Forward Surge Current

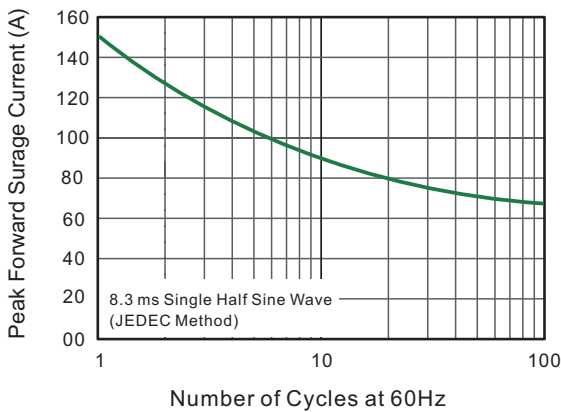
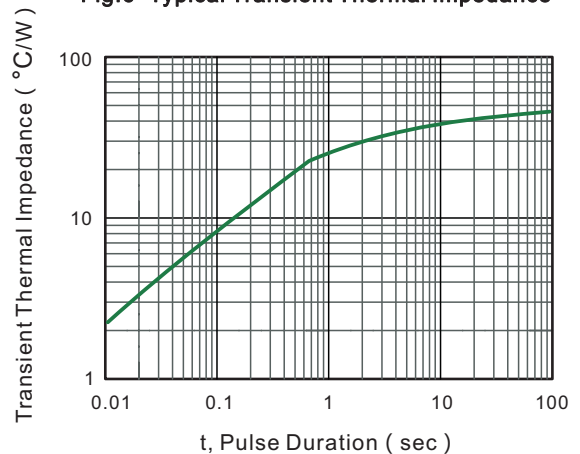

Fig.6- Typical Transient Thermal Impedance



PACKAGE OUTLINE

Plastic surface mounted package; 2 leads

TO-220AB

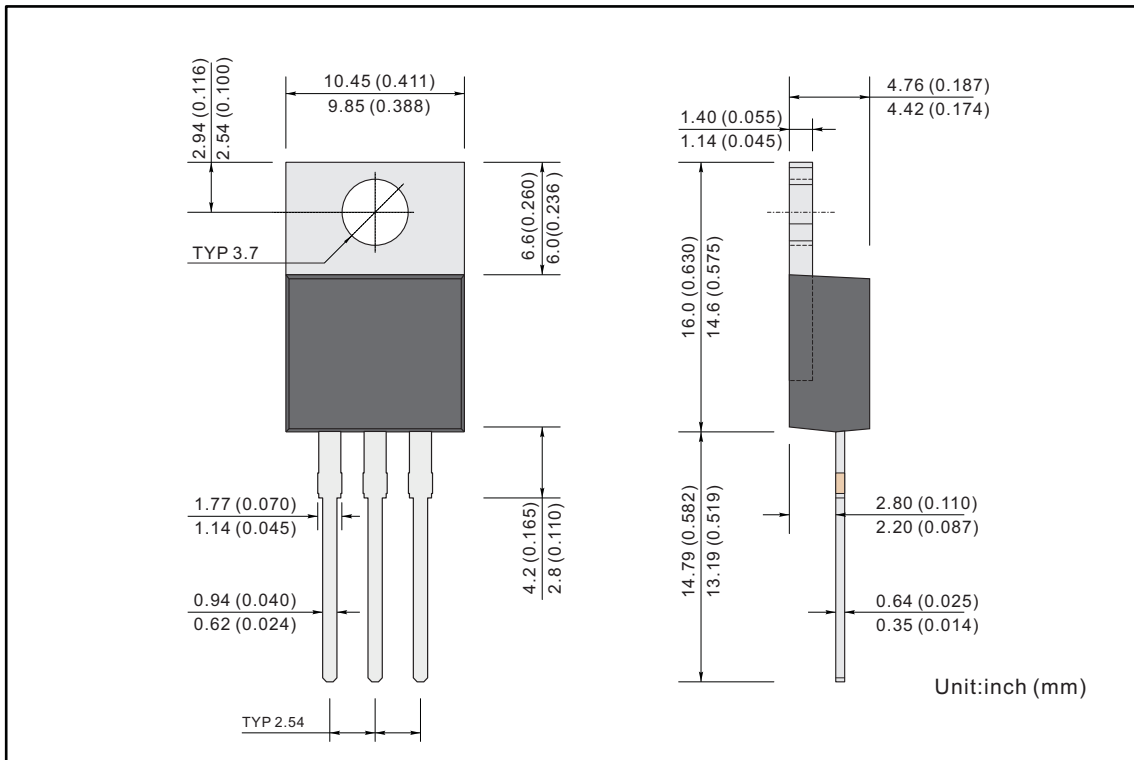

PACKAGE OUTLINE

Plastic surface mounted package; 2 leads

ITO-220AB

